



METAL DECK REPLACEMENT?  
ANY SIZE. ANY PLACE. ANY TIME.



[WWW.METALDECKSUPPLY.COM](http://WWW.METALDECKSUPPLY.COM)

DISTRIBUTION CENTERS

ALBANY, NY – ATLANTA, GA – AURORA, IL – COLUMBUS, OH – FT. WORTH, TX  
GREENSBORO, NC – HAGERSTOWN, MD – HOUSTON, TX – INDIANAPOLIS, IN – JACKSONVILLE, FL  
KANSAS CITY, MO – KNOXVILLE, TN – SAN ANTONIO, TX – ST. LOUIS, MO

# YOUR ONE-STOP METAL DECK SHOP

*If it's metal decking you need, you can rely on A.C.T., the metal deck experts!*

A.C.T. Metal Deck Supply stocks the metal deck and metal deck accessories you need for delivery or pickup. Whether you need immediate stock from our local warehouse or a preplanned custom fabricated order, we can get the deck you need.

A.C.T. Metal Deck Supply with a network of **14 Locations** and extensive inventory makes

us the largest distributor of metal deck in the country.

We stock all types, gauges, and finishes of Roof Deck, Form Deck, Composite Floor Deck and Corrugated Roofing & Siding.

We also have a complete inventory of "A", "B", "F", & "N" Deck and also provide

specialty items such as Long-span, Cellular, Stainless Steel and Acoustic Deck for your more sophisticated projects.

Our most popular accessories include weld washers, rubber closure, fasteners, pour stops and sump pans. We also do "take-offs" and detailing.

## SHOP BY PRODUCT

### DECK REPLACEMENT

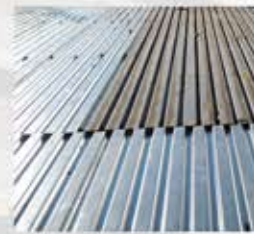

### ROOF DECK



"A" Roof Deck



"F" Roof Deck



"B" Roof Deck



"N" Roof Deck

### FORM DECK



9/16" Form Deck



1" Form Deck



1-5/16" Form Deck

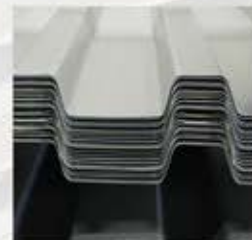

1.5" Form Deck

### CORRUGATED ROOFING & SIDING

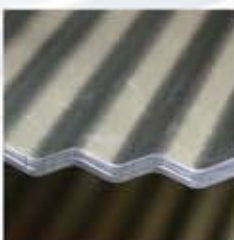

1/2" Roofing & Siding



7/8" Roofing & Siding

### ACCESSORIES



# WE HAVE THE METAL DECK YOU NEED RIGHT NOW



OUR MISSION AT A.C.T. METAL DECK SUPPLY IS TO FULFILL THE NEEDS OF THE METAL DECK USER WITH INTEGRITY AND RELIABILITY, WHILE PROMOTING THE PERSONAL GROWTH OF OUR EMPLOYEES AND THEIR FAMILIES.

Since 1970, A.C.T. Metal Deck Supply has prided itself on fulfilling the needs of the metal deck users in the building community.

Our 14 distribution centers allow us to meet your metal deck needs with lower costs, tighter turnaround times, and better service overall.

Our strong manufacturer relationships allow us to provide you with any size metal deck order, while meeting your lead times.

Save time and money by using A.C.T. Metal Deck Supply as your one-stop metal deck shop.

## METAL DECK PROFILES

### ROOF DECK

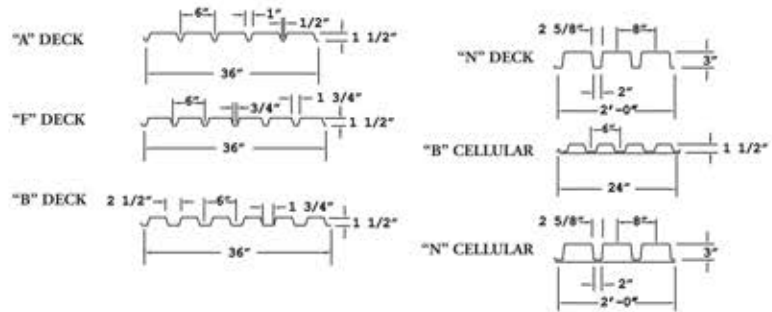

### COMPOSITE FLOOR DECK

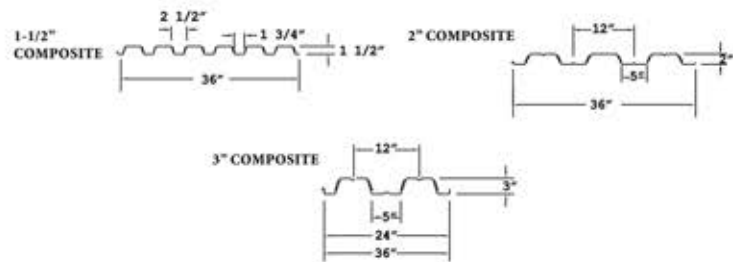

### FORM DECK \*

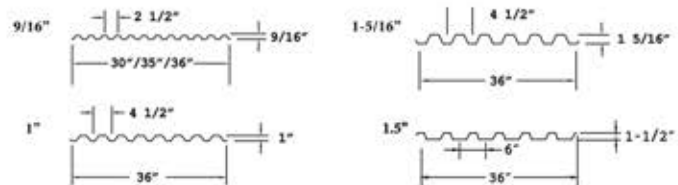

### ROOFING & SIDING

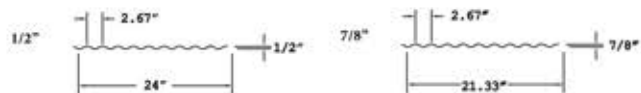

\* PITCHES VARY, PLEASE CALL TO CONFIRM

## ACCESSORIES



TEKS Self-Drilling Fasteners



Pour Stop / Cell Closure

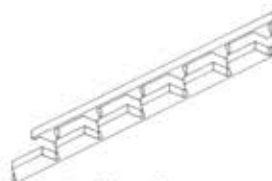

Rubber Closure

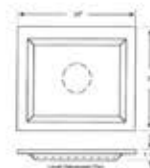

Sump Pans



Shop Drawings

Request a Proposal Online: [www.metaldecksupply.com](http://www.metaldecksupply.com)



LOCAL SOURCE – NATIONAL NETWORK

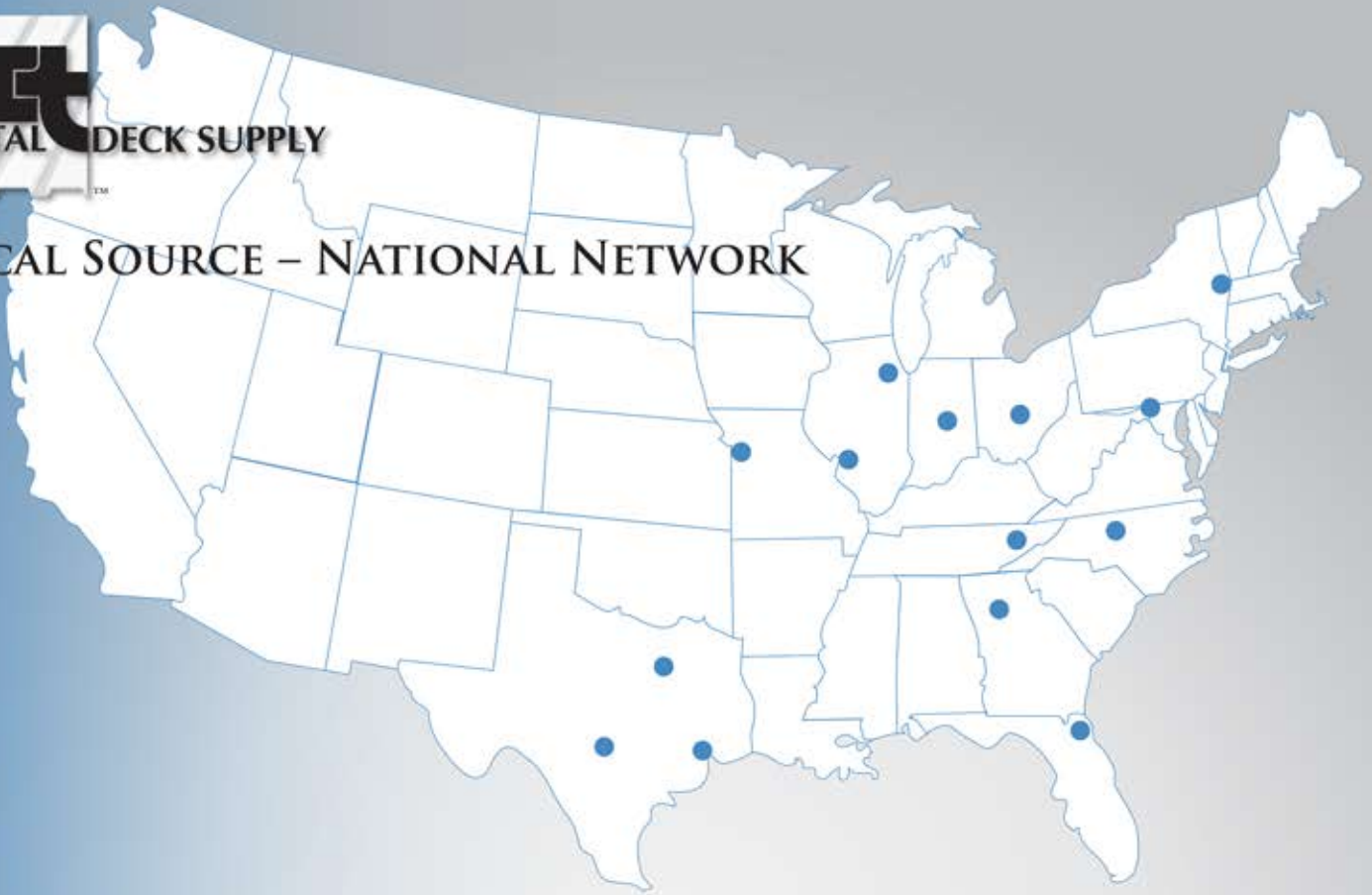

### DISTRIBUTION CENTERS

ALBANY, NY – ATLANTA, GA – AURORA, IL – COLUMBUS, OH – FT. WORTH, TX  
GREENSBORO, NC – HAGERSTOWN, MD – HOUSTON, TX – INDIANAPOLIS, IN – JACKSONVILLE, FL  
KANSAS CITY, MO – KNOXVILLE, TN – SAN ANTONIO, TX – ST. LOUIS, MO

CONTACT YOUR METAL DECK EXPERTS FOR A PROPOSAL TODAY!

800.894.7741 – 630.978.7800 – FAX 630.978.7825

EMAIL: [sales@metaldecksupply.com](mailto:sales@metaldecksupply.com)

[www.metaldecksupply.com](http://www.metaldecksupply.com)

*Visit Our Responsive  
Web Design which will fit  
the screen of any desktop,  
smart phone or tablet today!*



### MEMBER



### APPROVED



### DISTRIBUTOR

